

Date	SYM	REVISION RECORD	AUTH	DR.	CK.
9/28/07	A	Added "ROHS COMPLIANT"	T.B.	B.S.	
08/28/14	B	UPDATED TO ROHS 2 COMPLIANT	T.B.	B.S.	
06/16/17	C	UPDATED FUSE SPECIFICATION	T.B.	B.S.	

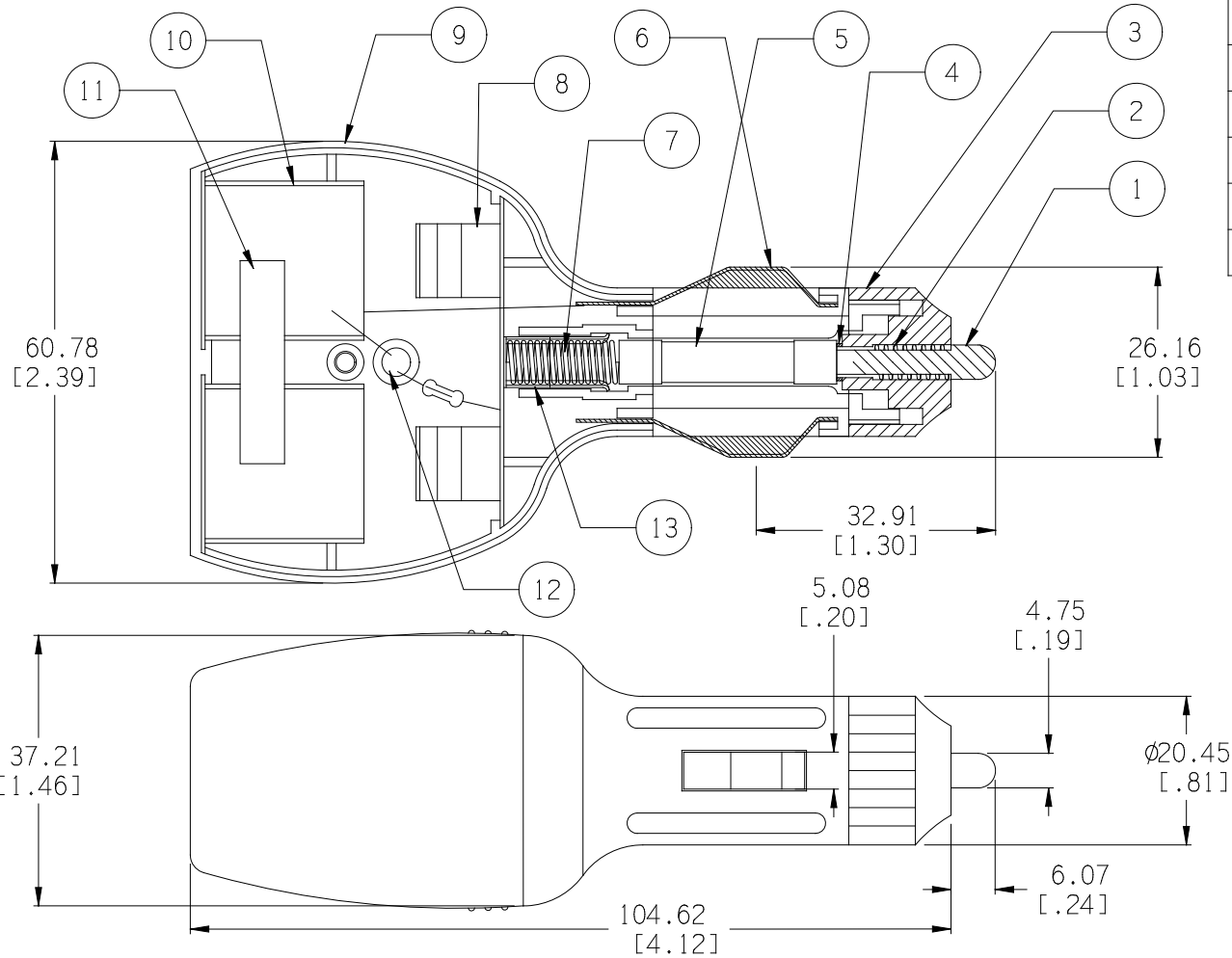

ITEM NO.	PART NAME	MATL. SPECIFICATION	QTY.
1	TIP CONTACT (+) TERMINAL	BRASS, NICKLE PLTD.	1
2	SPRING	STEEL WIRE; ϕ 0.45 THK	1
3	CAP	BAKELITE, BLACK	1
4	WASHER	BRASS, NICKLE PLTD.	1
5	FUSE	10 AMP. 6.3*30	1
6	(-) TERMINAL	STEEL, NICKLE PLTD	2
7	SPRING	PHOSPHOR BRONZE; ϕ 0.45 THK	1
8	(+) CONTACT	BRASS, NICKLE PLTD.	1
9	BODY	NYLON 66, GLASS FILLED	1
10	SOCKET	BRASS, NICKLE PLTD.; 0.6 THK	2
11	SHORTING BAR	BRASS; 0.6 THK	1
12	LED	ϕ 3 DC 12V	1
13	SPRING HOUSING	BRASS, NICKLE PLTD.	1

ROHS 2 COMPLIANT

Tolerance
(Inches)



Memory Protection Devices, Inc

200 Broad Hollow Road, Farmingdale, New York 11735

Decimal

$\pm .5$ (.020)

Fractional

$\pm .8$ (.030)

Angular

$\pm 3^\circ$

Scale

Drawn By B.S.

Approved By T.B.

Title

DUAL SOCKET SPLITTER, LED & 1A FUSE

Date

08/28/14

Drawing Number

ZA5018